

TEMPUR ARC™ Static, TEMPUR ARC™ Adjustable, TEMPUR ARC™ Storage

INSTRUCTIONS FOR USE AND WARRANTY

Contents

INSTRUCTIONS FOR USE	3
Welcome to TEMPUR®	3
GENERAL SAFETY INSTRUCTIONS - APPLICABLE FOR ALL BED TYPES:	
TEMPUR ARC™ Static, TEMPUR ARC™ Adjustable, TEMPUR ARC™ Storage	3
Symbols	4
Transport, moving, storage, and disposal	5
That 'new product' smell	5
Please note additional instructions for use	5
Fire safety	6
Installation	6
Cleaning and maintenance	6
ADDITIONAL INSTRUCTIONS FOR USING YOUR TEMPUR ARC™ ADJUSTABLE AND STORAGE BED	7
ADDITIONAL INSTRUCTIONS FOR USING YOUR TEMPUR ARC™ STORAGE BED	8
ADDITIONAL INSTRUCTIONS FOR USING YOUR TEMPUR ARC™ ADJUSTABLE BED	8
Troubleshooting	9
List of accessories and spare parts	9
Additional info about cleaning and maintenance of electrical components	10
Disposal of electrical components	10
Dismantling the motor unit	11
WARRANTY	13

In case of any discrepancy between the meanings of any translated versions of this text, the meaning of the English language version prevails.

INSTRUCTIONS FOR USE

Welcome to TEMPUR®

Thank you and congratulations on choosing TEMPUR®. This guide includes everything you need to know about caring for and getting the best out of your TEMPUR ARC™ product.

GENERAL SAFETY INSTRUCTIONS - APPLICABLE FOR ALL BED TYPES: TEMPUR ARC™ Static, TEMPUR ARC™ Adjustable, TEMPUR ARC™ Storage

In the following chapters, the references below will be used to draw your attention to possible dangerous situations. Please be aware that failure to comply with these instructions may result in critical injuries or damage to the product.



DANGER

Be aware of an immediate dangerous situation, which can cause death or critical injuries, if not avoided.



WARNING

Be aware of a dangerous situation, which can cause death or critical injuries, if not avoided.



CAUTION

Be aware of a dangerous situation, which can cause minor or moderate injuries, if not avoided.

IMPORTANT









Be aware of a dangerous situation, which can cause damage to the product and/or other property, if not avoided.







NOTICE

Direct attention to practical instructions and good advice.

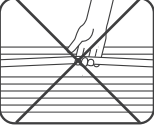
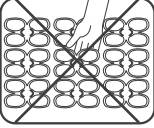
Symbols

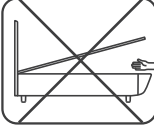
The following symbols are used on product, packaging or in this manual.

	Open the packaging carefully, so as not to damage the product and its parts. Dispose of the packaging safely and as sustainably as possible in your local area.			Do not cut deep into the packaging. Handle with care.	
	Assemble the product with two persons		Keep dry		Humidity level
	Avoid open flame		CE marking on electrical equipment		Consult instructions for use

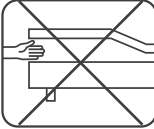
				
Be aware not to carry the frame only holding it from the middle of the slats or discs		Keep your feet a safe distance		
				
Head end	Foot end		Avoid playing with the appliance	Avoid fingers being trapped

Transport, moving, storage and disposal



CAUTION

- Do not attempt to move the bed and its parts by yourself, as this may cause injury. Do it with two people.
- Store the product in a dry environment (max. 65% relative humidity).
- Always follow the safety instructions in the assembly guides and on the product quality label sticker (placed on the backside of the headboard).

IMPORTANT

Packaging should be sorted into recyclable components and then disposed of in accordance with the appropriate national environmental regulations. Check with your local authority or retailer for recycling advice.

That 'new product' smell

Some people notice a slight odour to their new TEMPUR ARC™ product once unpacked. This is completely harmless and will disappear after a short period of use.

Please note additional instructions for use

Please read the following information clearly as this will provide guidance on how to use your product and what to expect in the first few months.



WARNING

- For domestic use only.
- Immediately dispose of all packaging materials as they may pose a suffocation risk.
- Do not use accessories/attachments that are not recommended by the manufacturer.

IMPORTANT

- The product should not be used in a moist environment.
- Avoid the use of this product outdoors.
- This should not be used in any application that will be cleaned with an automated washing system.
- In accordance with our recommended use (sleeping, sitting, and sitting along the edge), weight restrictions of a maximum 150kg (moving weight) over the whole bed surface is admissible without restrictions.

Please note that the manufacturer cannot be held responsible for overloading.

Fire safety

TEMPUR ARC™ Bed Range products comply with applicable safety standards, which may vary depending on the product or the region. Further information is available upon request. Carelessness causes fire - we strongly recommend not to smoke in bed.



WARNING

- Risk of fire: keep products away from open flames

Installation

For a correct and safe installation, PLEASE SEE THE ASSEMBLY GUIDES FOR FURTHER INSTALLATION INSTRUCTIONS.

Cleaning and maintenance

A clean bedroom can have a big impact on your sleeping environment and therefore sleep quality.

To ensure the preservation of your bed's appearance, we recommend regular vacuuming with a soft fitting, preferably once a week. This gently removes the dust from the surface without damaging the textile and reduces dust collection.

IMPORTANT

- Always remove stains as quickly as possible before it penetrates the fibers. This may result in a permanent stain.
- Avoid soaking as this can seep through the fabric and damage the underlying material.
- DO NOT rub the material too hard to remove a stain as this may damage the material.

NOTICE

- If liquid spills, absorb as much of the liquid as possible with a plain white kitchen paper towel or cotton cloth to avoid a permanent stain.
- Most spots can be removed with lukewarm water, possibly with a pH-neutral dishwashing detergent.
- If a stain or spot has dried, remove as much as possible by vacuuming with a soft brush fitting.

ADDITIONAL INSTRUCTIONS FOR USING YOUR TEMPUR ARC™ ADJUSTABLE AND STORAGE BED

Please read the following information clearly as this will provide guidance on how to use your product and what to expect in the first few months.



WARNING

- Only use this TEMPUR ARC™ Adjustable and Storage bed for its intended use, as described in this manual.
- This appliance can only be used by the below users when supervised or instructed on safety use and full understanding of resulting risks.
 - These users include:
 - Children of 8 years and older
 - Persons with reduced physical, sensory or mental capabilities
 - Persons with lack of experience or knowledge
- Children should be supervised to ensure that they do not play with the appliance.
- The cleaning and user maintenance must NOT be carried out by children without supervision.
- It is not advised to allow children and/or pets to play on or under the bed.
- Do not use accessories/attachments that are not recommended by the manufacturer.

ADDITIONAL INSTRUCTIONS FOR USING YOUR TEMPUR ARC™ STORAGE BED



WARNING

- Keep your head away from the frame. Be very careful not to hit your head while opening the frame. Be aware that during opening, on the middle way up the lifting mechanism applies powerful force to lift the system up to the end.



CAUTION

- While opening and closing the storage bed, be careful not to trap your fingers in the hinges or under the storage frame.

ADDITIONAL INSTRUCTIONS FOR USING YOUR TEMPUR ARC™ ADJUSTABLE BED



DANGER

- Do not use in any environment where combustible, explosive gases or vapors may be present. (e.g. anesthesiology)



WARNING

- Batteries included with the electronic accessories are not rechargeable and are not to be placed in a battery charger.



CAUTION

- Do not sit or stand on the frames ends while they are in raised positions.
- When adjusting the position of the bed base, be extra careful not to get your fingers caught in the mechanism.

IMPORTANT

- Do not use for raising and lowering loads in industrial or technical applications.
- Avoid forces which exceed specified ratings on the ratings plate on the motor.
- To prevent the distortion of fittings, the Adjustable bed base must be placed on an even surface.



CAUTION

- Electrical components should be connected or disconnected only when the power supply cord is unplugged.

Troubleshooting

This chapter describes troubleshooting methods for fixing problems during installation and daily use.

PLEASE CHECK THE ADJUSTABLE FRAMES ASSEMBLY GUIDES FOR PAIRING AND UNPAIRING OF REMOTES AND MOTORS

What do you do in case of error:

If you experience an error that is not listed in the table below, please contact your sales agent/supplier.

Problems	Possible cause	Solution
The remote control or motor system is not functioning.	There is no mains supply voltage.	Connect the mains power.
The drive is suddenly incapable of movement.	The remote control or motor is defective.	Please contact your sales agent.
	The remote control battery is empty.	Check the battery and replace if necessary.
	A lead-in connection has been Interrupted.	Check the cables and reinsert them, if required.

List of accessories and spare parts

Accessories		Spare parts	
83715503	Set of mattress side stoppers	83715290	Motor Premium
83715283	Storage Mesh Net 135x190cm	83715291	Motor Entry
83715284	Storage Mesh Net 140x200cm	83715292	Remote Premium
83715285	Storage Mesh Net 150x200cm	83715293	Remote Entry
83715286	Storage Mesh Net 160x200cm		
83715287	Storage Mesh Net 180x200cm		

Additional info about cleaning and maintenance of electrical components

NOTICE

- Always disconnect the power supply before you start to clean the drive system!
- Never clean the motor unit in an automated washing system or with a high-pressure cleaner.
- Do not allow fluids to penetrate the unit. Damage to the system could result.
- Do not use a cleanser that contains benzene, alcohol, or similar solvents.
- Clean the electrical components as needed using a dry anti-static cloth.
- Make sure that you do not damage the drive's connecting cable.

Disposal of electrical components

To protect the environment and the best possible reutilization, we recommend you follow the recycling advice below:

Electrical and electronic components

In light of Environmental Protection, waste electrical products should not be disposed of with household waste. Please recycle where facilities exist. Check with your local authority or retailer for recycling advice.

Electrical and electronic equipment contains materials, components, and substances that may be hazardous and present a risk to human health and the environment when not handled correctly.

Equipment marked with the below crossed-out wheeled bin is electrical and electronic equipment. The crossed-out wheeled bin symbol indicates that electrical and electronic equipment should not be discarded with unsorted household waste, but must be collected separately.



Electrical and electronic equipment must not be discarded together with household waste. Residents must use the collection schemes available to reduce adverse environmental impacts in connection with disposal of waste electrical and electronic equipment and to increase opportunities for reuse, recycling, and recovery of waste electrical and electronic equipment.

Dismantling the motor unit



CAUTION

- Electrical components should be connected or disconnected only when the power supply cord is unplugged.
- Danger of pinching/crushing injuries!
Be sure to carry out work on the drive in a position so that no loads bear on it.
This is to ensure you avoid any risks of crushing or injury.



The disposal of the three-volt batteries is regulated in the EU by Battery Directive 2006/66/EC, and internationally by any applicable national laws and regulations. The battery should not be disposed of with normal household waste. Check with your local authority or retailer for recycling advice.

1. Move your product into a position where it is not supporting a load.
2. Disconnect the motor from the power supply!
3. Disconnect all the connecting cables.
4. Remove the inner frame and turn it upside down.
5. Pull firmly on the shutters (A) sideways until they are completely removed.
6. Pull out the motor far enough so that the brackets (C) are out of the slots (B).
7. The motor is now unattached and can be removed.
8. Push the shutters (A) back into the motor so that they are not lost during transportation.

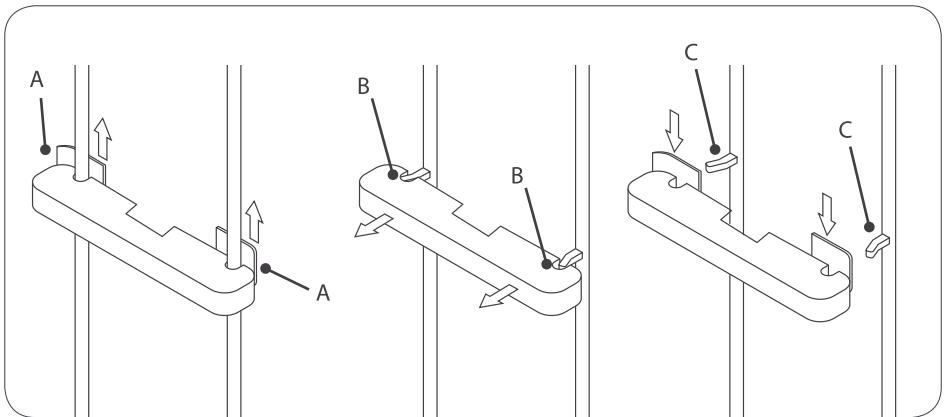

DECLARATION OF CONFORMITY

The manufacturer, Osaühing Bed Factory Sweden, a subsidiary of Tempur Sealy International, Inc. registered in Riia 66, EE-71009 Viljandi, Estonia, declare that the following product,

TEMPUR ARC™ Adjustable Bed bases

as delivered, is in conformity with the requirements of the following EU directives and standards:

Directives	Subject
Directive 2006/42/EC	Machinery
Directive 2011/65/EU	RoHS
Directive 2014/35/EU	LVD (Low Voltage Directive)
Directive 2014/53/EU	RED (Radio Equipment Directive)
Directive 2014/30/EU	EMC (Electromagnetic Compatibility)
Directive 2009/125/EC	Ecodesign

Standards	Subject
Standard ISO 19833:2018	Furniture — Beds — Test methods for the determination of stability, strength, and durability
Standard EN1725:1998	Domestic furniture. Beds and mattresses. Safety requirements and test methods
Standard EN 13759: 2012	Furniture. Operating mechanisms for seating and sofa-beds. Test methods

This declaration of conformity is issued under the sole responsibility of the manufacturer. Directives and standards are accompanied by technical product documentation, which proves the compliance of the product.

This declaration of conformity is no longer valid if significant changes are made to the design and/or the construction, which have influence on the technical documentation.

Signed for and on behalf of:
 Osaühing Bed Factory Sweden,
 A subsidiary of Tempur Sealy International, Inc.
 Riia 66, EE-71009 Viljandi, Estonia



Indrek Aasna - Managing Director

WARRANTY

TEMPUR® WARRANTY

This document sets out the terms and exclusions of the TEMPUR® Warranty for new TEMPUR® products sold to consumers worldwide (excluding the USA and Canada).

Who offers the TEMPUR® Warranty?

The Manufacturer of TEMPUR ARC™ beds is Bed Factory Sweden OÜ, a company registered in Estonia under company registration number 11133916. Registered office address: Riia mnt 66 Viljandi 71009, Estonia. Bed Factory Sweden OÜ (the Manufacturer) is a subsidiary of TEMPUR-Sealy International, Inc.

What is covered?

The Manufacturer warrants that all new and genuine Tempur ARC™ Beds are free from material defects due to faulty workmanship or materials for the applicable warranty period (see section - For how long?) unless the product is specifically excluded, or an exclusion applies (see section - Exclusions).

The TEMPUR ARC™ bed Warranty is valid for products purchased by consumers anywhere in the world from the Manufacturer or an authorised retailer for personal use and not in the course of a business, trade, or profession. A list of authorised retailers is available at www.tempur.com

For how long?

The TEMPUR® Warranty lasts for the period displayed on or inside the packaging of the relevant product or as stated below, starting from the date of purchase (except where the product is an ex-display or demonstration model in which case the warranty starts from the date of manufacture).

The warranty period is generally as set out in the warranty table, but the Manufacturer advises that you should check the warranty terms for the country in which you originally purchased your product as there may be a different warranty period applicable. For this, please visit www.tempur.com

In case of any discrepancy between the meanings of any translated versions of this text, the meaning of the English language version prevails.

Product: Beds and bed parts	Product Warranty	What's covered?
TEMPUR ARC™ Bed Bases (outer frames) and Headboards	10 years	Material defects due to faulty workmanship or materials.
TEMPUR ARC™ Bed inner frames (static slatted, static disc, adjustable slatted, adjustable disc, storage)	5 years	Material defects due to faulty workmanship or materials.
TEMPUR ARC™ Bed adjustable beds electrical components: motor, remote control.	3 years	Material defects due to faulty workmanship or materials.

What will we do?

Where a valid claim is made in accordance with this TEMPUR ARC™ bed Warranty, the Manufacturer shall offer, at its choice, either to repair the defective product or provide an equivalent replacement product free of charge.

The Manufacturer will refund the reasonable delivery cost of returning a defective product for repair or replacement so long as the claim is valid under the terms of this TEMPUR® Warranty and the product is returned from an address within the same country as the authorised retailer the product was purchased from. The repaired or replacement product will be delivered free of charge to an address within the same country as the authorised retailer the product was purchased from. In all other circumstances, any delivery costs associated with any repairs or replacements are the purchaser's responsibility.

In the event of replacement, the Manufacturer shall endeavour to provide a replacement product from the same line. However, if the product line has been discontinued or the product is otherwise not available, the Manufacturer reserves the right to provide a replacement product that, in the Manufacturer's sole discretion, is similar to the defective product.

The TEMPUR ARC™ bed Warranty provides cover from the date of purchase (or date of manufacture in the case of ex-display/demonstration products) of the original product. It is not renewed on the provision of a repaired or replaced product. In these circumstances, the TEMPUR ARC™ Warranty will run for the remainder of the period starting from the original purchase or manufacture date, as applicable.

Exclusions

The TEMPUR® Warranty does not apply if:

- the product has been purchased used, second hand or from anyone other than an authorised retailer or directly from the Manufacturer. A list of authorised retailers is available at tempur.com
- the process for making a claim under the TEMPUR ARC™ bed Warranty (set out under the heading "How do you claim under the TEMPUR ARC™ bed Warranty?" below) has not been correctly followed.
- the product has not been used and/or handled with due care and/or in accordance with the instructions of use, cleanliness and maintenance described in the Instructions for Use and at tempur.com
- the product has been deliberately damaged or damaged as a result of neglect, cuts, burns, flooding or any other improper use by you or by any third party.
- the product has been wet or soaked against Manufacturer's recommendations.
- the product is found to be very stained, soiled and/or otherwise unhygienic.
- the product has been altered or repaired without the Manufacturer's prior permission.
- the defect is the result of normal wear and tear.
- There has been opened or tampered with the motors or remote; with the exception of battery compartments, the warranty will be void if the internal workings of these components are tampered with.
- Has been overloaded or misused against the manufacturer's weight restrictions.

How do you claim under the TEMPUR® Warranty?

To claim under the TEMPUR ARC™ Warranty you must:

- contact the authorised retailer you originally purchased the product from (the "Seller"). If the Seller is either no longer in business or is no longer a TEMPUR ARC™ bed authorised retailer, please contact the Manufacturer.
- present the original invoice or sales receipt as evidence of the purchase.
- return the product to the Seller or to the Manufacturer (but only if the Manufacturer has requested the product). If the Manufacturer determines that the claim is valid in accordance with the terms of this TEMPUR ARC™ bed Warranty, you will be refunded the reasonable delivery costs for returning the defective product, so long as the product has been returned from an address within the same country as the Seller.

Our liability to you

The liability of the Manufacturer is limited to the cost of repair and/or replacement of the product under the TEMPUR ARC™ bed Warranty. Accordingly, the Manufacturer will not be liable for all other liability for loss or damage howsoever caused arising out of the purchase, possession, sale, or use of the product. However, the Manufacturer does not exclude or limit in any way its liability for death or personal injury caused by its negligence, or fraud or fraudulent misrepresentation.

The products are only sold for domestic and private use. The Manufacturer has no liability to you for any loss of profit, loss of business, business interruption, or loss of business opportunity.

Your legal rights

The TEMPUR ARC™ bed Warranty does not affect a consumer's statutory rights under applicable law but aims to enhance the consumer's rights where applicable.